

1LM.051.0163

出轴尺寸

2:1

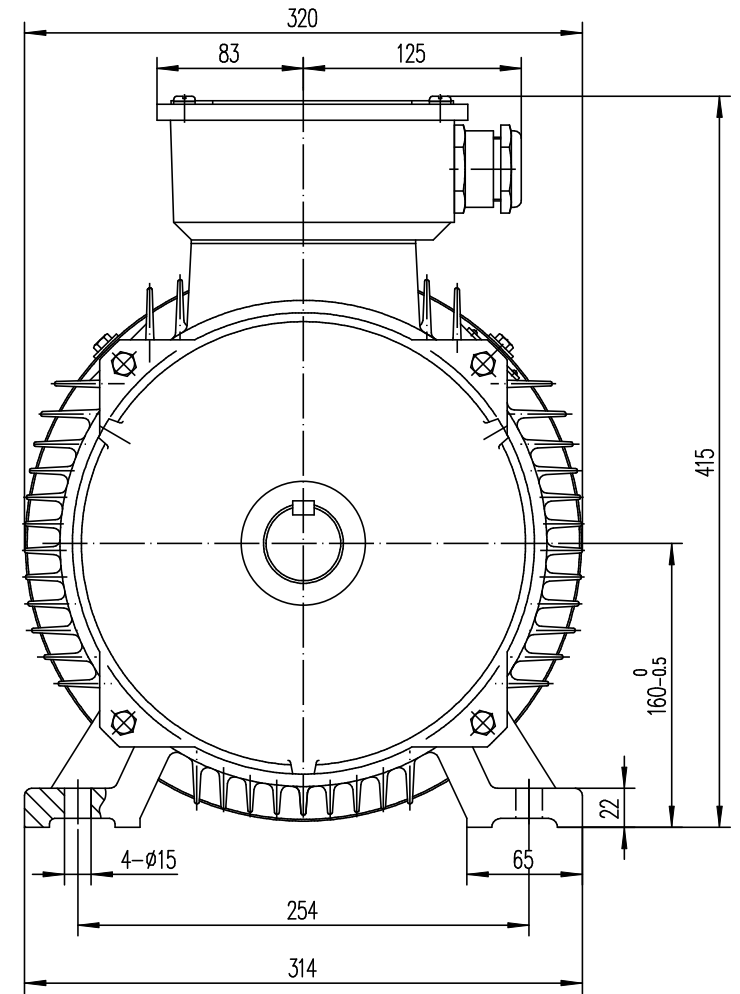
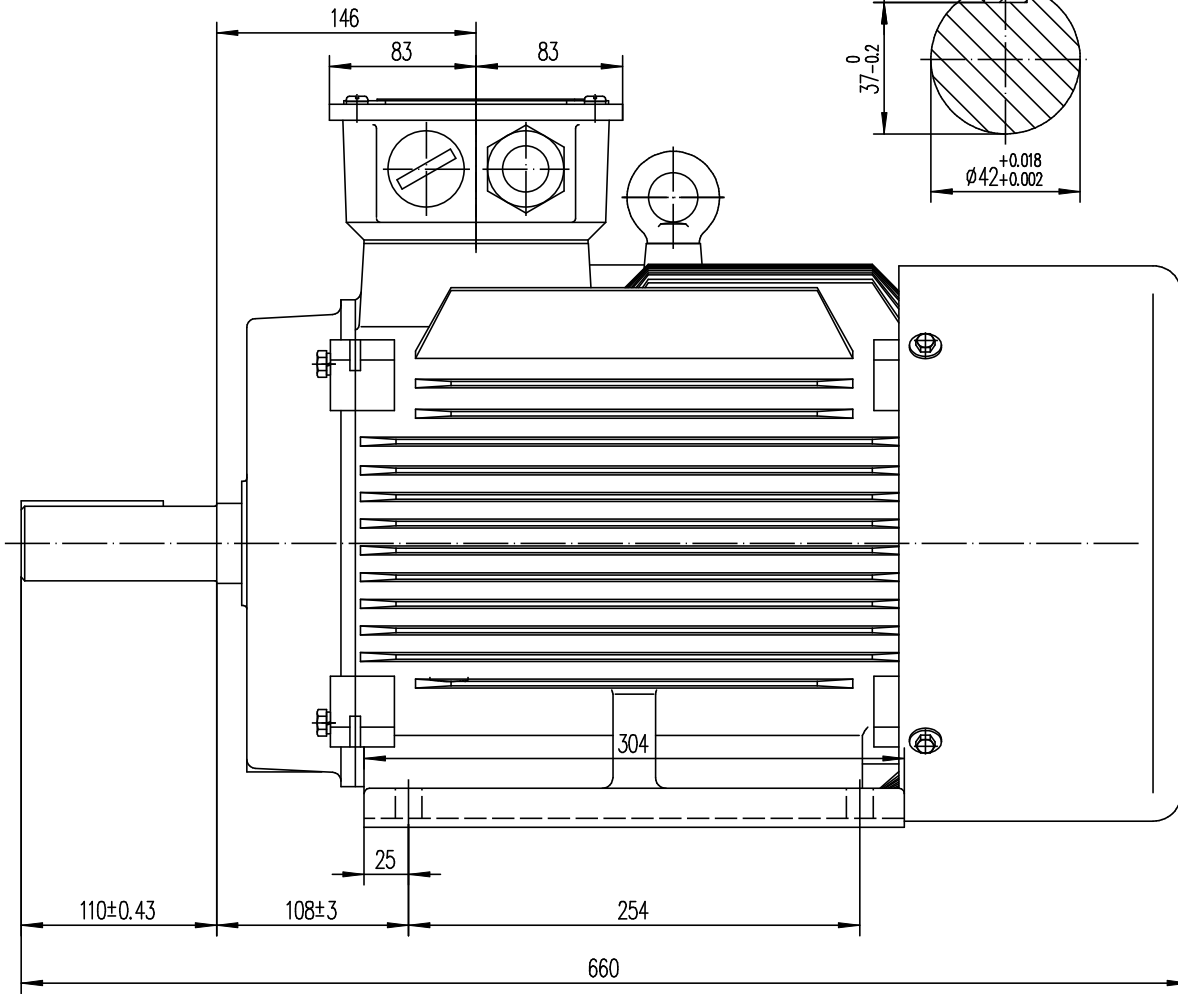
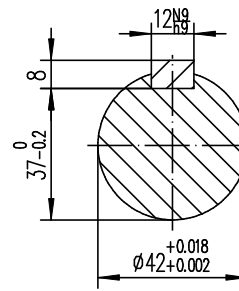

借 (通) 用 件 登 记
旧底图总号
底图总号
签 字
日 期
档案员 日期

Unit	mm	LE3-160L B3	
Date	2014.12		
NER GROUP CO.,LIMITED		1LM.051.0163	
www.sogears.com			